

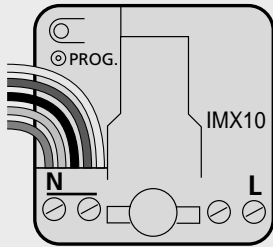

**XanuraHome™**  
Interface module type IMX10  
MBO 6019570G01 001



### XanuraHome™ Interface module type IMX10

XanuraHome interface module for installation behind (rocker) switches or retractive switches. Suitable for controlling various XanuraHome modules (actuators) through ON, OFF, DIM, BRIGHT, All Lights On, All Units Off or All Lights Off commands. The IMX10 can also be used behind a (rocker) switch or retractive switch to start programming macros in, for example, a XanuraHome Control Box.

**Note:** XanuraHome built-in modules should always be installed in a junction box or distribution box.

**Note:** Inputs are only suitable for potential-free switches or contacts <+5 volts with respect to Neutral.

#### Functions

- Can send ON, OFF, DIM, BRIGHT, All Lights On, All Units Off or All Lights Off commands (depending on the programming).
- Four inputs can be programmed independently in terms of address (A1 to P16) and function.
- Adjustable for fixed mode or toggle mode sending of ON/OFF commands.

- The dimmer interface is adjustable for use with retractive switches with one or two, normally open contacts (optionally with zero position, multi-switch).
- Can be used as mechanical ventilation interface in combination with a retractive switch with four normally open contacts with zero position (multi-switch).
- Adjustable for automatic request for status information (two-way communication, status request).
- Adjustable for receipt of group commands for a status update in toggle mode.

#### Connection applications

Suitable for the connection of:

- Four 1-pole (rocker) switches.
- Four 1-pole, normally open contact, retractive switches.
- Two retractive switches with two normally open contacts (optionally with zero position, multi-switch).
- One retractive switch with four normally open contacts (optionally with zero position, multi-switch).
- Four random potential-free contacts with a common contact (P contact).

42 MBO 6019570G01 001



MBO 6019570G01 001 43

### XanuraHome™ Interface module type IMX10

#### Connecting wires- colour code for standard programming

The input wires are given an address and function that depend on the programmed address and function. Please see the programming chapter for the colour coding.

**Please note:** The blue input wire of the IMX10 is connected internally to the neutral terminal. Make sure that the phase and neutral connections are correctly connected to the module. If phase and neutral are swapped, there will be 230 V on the input wires of the module.

#### Legend for the connecting wires

**Installation wires:**

- = Brown (L or phase)
- = Blue (N or neutral)
- = Black (Switch wire)

**Ingangsdraden:**

- = Blue (XanuraHome module common wire)
- = Brown (XanuraHome module Input wire 1)
- = Red (XanuraHome module Input wire 2)
- = Orange (XanuraHome module Input wire 3)
- = Yellow (XanuraHome module Input wire 4)

44 MBO 6019570G01 001



### Installation/assembly behind switches & retractive switches

**Always switch off the power before commencing installation.**

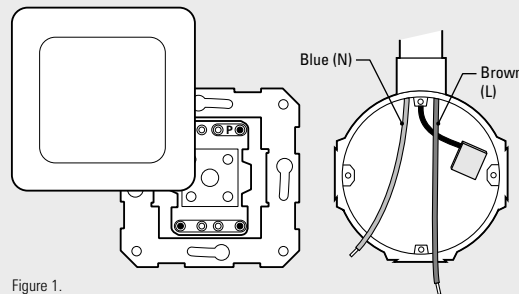

Figure 1.

- Remove the switch from the junction box.
- Disconnect the wiring from the switch.
- Put in a neutral wire (N) if it is missing.



MBO 6019570G01 001 45

### Installation/assembly behind switches & retractive switches

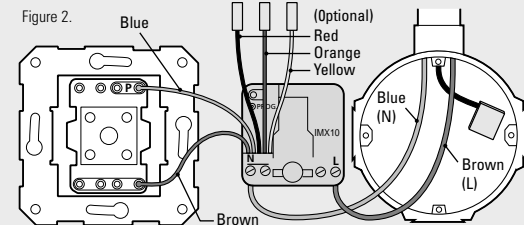

- Connect the phase wire (L) to the L connection of the module and the neutral wire (N) to one of the neutral connections (N).
- Connect one or more of the module's input wires to the switch contact of the switch. This depends on the application. The input wires that are not connected must be insulated. Connect the blue input wire of the module to the P terminal of the switch.

**Max. tightening torque**

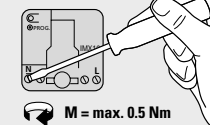

46 MBO 6019570G01 001



**Installation/assembly behind switches & retractive switches**

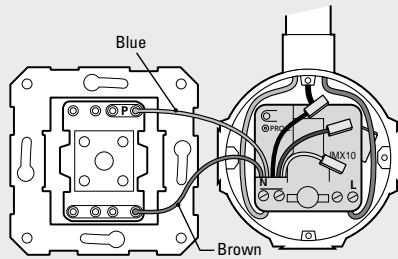

Figure 3.

- Position the module with the back against the rear of the junction box, behind the wiring.
- If the module has not yet been programmed or has been incorrectly programmed, then it can now be programmed.

→ Please see the chapter on programming.

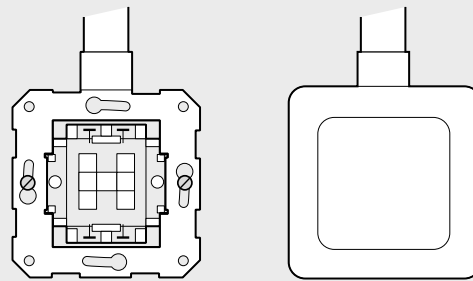

Figure 4.

- After programming, place the switch back in the junction box and click the push button with the cover frame back on the switch.

**Programming Introduction**

**⚠ Switch on the power supply before you start programming. Avoid touching live parts!**

The introduction to this chapter describes the basic programming actions. This is followed by a description of the two programming methods:

- Programming per function (simple and usually sufficient).
- Programming per input (more complex but also more versatile).

**Programming per function**

When programming per function, one function/operation is determined for the module and one address is determined, after which the other inputs are automatically given the same function (or a variant of this function) and consecutive addresses.

**Programming per input**

When programming per input, a separate function and random address (A1 to P16) can be programmed for each input. See the chapter on programming per input for the right procedure to follow.

**Programming Introduction**

This chapter explains the various actions that need to be performed to program the module.

**Basic programming actions**

Module programming consists of six steps that must **always be performed in the specified order**. To program the interface module proceed as follows:

1. Set the module in to Programming mode.
2. Program the address twice.
3. Program a function code twice.
4. Program any options twice.
5. Exit the Programming mode.
6. Test the operation of all the inputs.

**⚠ Please note:**

If, immediately after putting the module in Programming mode, an address is sent twice, the module will return to the default value for function and options (reset).

**Introduction**

**1. Switch the module to Programming mode**

In order to program the interface module, it must be set in to the Programming mode as follows:

- Press the programming button for at least three seconds (see Figure 5). The red LED will light up and stay on after releasing the button.

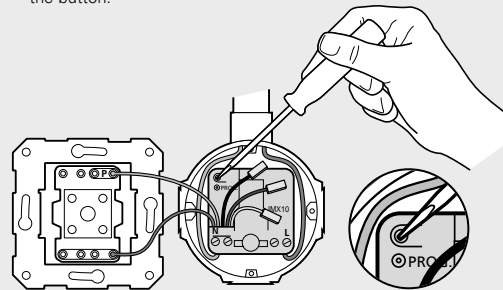

Figure 5. Activating and deactivating the Programming mode.

**Programming Introduction**

**2. Programming the address**

Send the set-up command (letter and figure code) that belongs to the desired address twice via the power line using a programming unit (PUX), a XanuraHome Control Box or another A10/X10-compatible transmitter (e.g. a remote control). The LED will flash twice after two identical set-up commands (addresses) have been received. A detailed description of the steps to be followed when programming and the various programming options can be found in the XanuraHome Step by Step Plan. This can be found at [www.xanurahome.nl](http://www.xanurahome.nl)

Standard	Optional	Set-up command	No. of LED flashes
Address A1	A2...P16	Address 2 x	2 x

**After sending the address, the other inputs will automatically be assigned consecutive addresses. To assign a specific address per input, see the chapter on programming per input.**

**Introduction**

**3. Programming a function code**  
 Determine the function of the module by sending the set-up command belonging to the function twice via the power line (see following table). The LED responds with a number of flashes according to the selected function once two identical set-up commands have been received.

Function (sending)	Set-up command	No. of LED flashes
3.1 On/Off switch commands (switch or pushbutton switch)	ON	3 x
3.2 Dimming commands via 1-pole, normally open, contact retractive switch	BRIGHT	5 x
3.3 Dimming commands via retractive switch with two normally open contacts	DIM	6 x
3.4 Group commands	ALN	8 x
3.5 Commands for mechanical ventilation control	HRQ*	12 x

\* Cannot be programmed using a remote control.  
 ALN = All Lights On, HRQ = Hail Request

The programming per function chapter explains how to program the above functions with helpful examples.

**EATON** MBO 6019570G01 001 53

**Programming Introduction**

**4. Programming options**  
 The IMX10 has the option of converting the internal status (from ON to OFF or from OFF to ON) upon receiving a group command: All Lights On, All Lights Off, All Units Off.

This option is **only** applicable with the following functions:  
 A. Sending On/Off switch commands with switch or with 1-pole, normally open contact, retractive switch.  
 B. Sending dimming commands with 1-pole, normally open contact, retractive switch.

 The application of this option depends on how the IMX10 is used. If the IMX10 controls a switch actuator that responds to a group command, the options of the IMX10 will also have to respond to the same group commands. As a result, the status of the interface (IMX10) will always be synch with the switch actuator.

**EATON** MBO 6019570G01 001 54

**Introduction**

**Example**  
 A switch actuator is controlled using an IMX10, operated with a (rocker) switch. The switch actuator responds to the group commands All Lights On and All Units Off. If the interface module sends an ON command, the switch actuator will switch on. When the switch of the IMX10 is pressed afterwards, the module would normally give an OFF command. However, if the actuator is switched off by an All Units Off group command, the IMX10 must change its internal status accordingly, so that an ON command is sent when the button is next pressed.

If you wish to set one or more options, the following actions should be taken:

- Send the desired command twice from "Set-up command" using the PUX programming unit, the XanuraHome Control Box or another A10/X10-compatible transmitter (such as a remote control)\*.
- The programming LED confirms the "Set-up command" with a specific number of flashes.
- Exit Programming mode.

\* Not all functions can be programmed using an A10/X10-compatible transmitter (e.g. a remote control).

**EATON** MBO 6019570G01 001 55

**Programming Introduction**

Option to be set*	Set-up command	No of LED flashes
Must respond to All Units Off	AUF	4 x
Must respond to All Lights On	ALN	2 x
Must respond to All Lights Off	ALF	3 x

AUF = All Units Off  
 ALN = All Lights On  
 ALF = All Lights Off

**5. Exit the Programming mode**

- Briefly press the programming button once; The red LED should now be off, or wait 60 seconds and the Programming mode will automatically be switched off.

 **Please note:**  
 If no set-up command has been received within 60 seconds, the module will automatically exit the Programming mode.

**6. Test the operation of all the inputs**

**EATON** MBO 6019570G01 001 56

**Programming per function**

**Programming per function**  
 This chapter explains the actions that need to be performed to program the module on the basis of function. See page 53 for the functions.

**3.1 Sending On/Off switch commands with a (rocker) switch or 1-pole, normally open contact, retractive switch**

Send an address (2 x)	A1...P16
Send set-up command (2 x)	ON
Send set-up command for any options (2 x)	ALN, ALF, AUF

**Example of programming on address B03**

Action	No. of LED flashes
Send address B03	2 x
Send set-up command ON (2 x)	3 x

**Optional:**  
 If the status of the module has to change with group commands All Lights On and All Units Off.

Send All Lights On (2 x)	2 x
Send All Units Off (2 x)	4 x

**EATON** MBO 6019570G01 001 57

**Programming per function**

**Result**

- ON/OFF function available for all inputs.
- Other inputs are automatically given consecutive addresses.

Input	Address	Sending*	Operation
Brown	B03	ON/OFF	Send ON* or OFF* commands
Red	B04	ON/OFF	Send ON* or OFF* commands
Orange	B05	ON/OFF	Send ON* or OFF* commands
Yellow	B06	ON/OFF	Send ON* or OFF* commands

\* Depends on the status of the switch actuator or address to be controlled (toggle mode).

**EATON** MBO 6019570G01 001 58

**per function**

**3.2 Sending dimming commands with 1-pole, normally open contact, retractive switch**

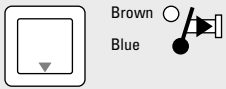

Send address (2 x)	A1...P16
Send set-up command (2 x)	Bright
Send set-up command for any options (2 x)	ALN, ALF, AUF

**Example of programming on address B03**

Action	No. of LED flashes
Send address <b>B03</b> (2 x)	2 x
Send set-up command <b>BRIGHT</b> (2 x)	5 x

Optional:  
If the status of the module has to change with group commands All Lights On and All Units Off.

Send All Lights On (2 x)	2 x
Send All Units Off (2 x)	4 x

**EATON** MBO 6019570G01 001 59

**Programming** per function

**Result**

- Dim function available for all inputs.
- Other inputs are automatically given consecutive addresses.

Input	Address	Sending*	Operation
Brown	B03	ON/OFF BRIGHT/DIM	Short pulse (< 0.5 s) ON or OFF, Long pulse (> 0.5 s) DIM or BRIGHT
Red	B04	ON/OFF BRIGHT/DIM	Short pulse (< 0.5 s) ON or OFF, Long pulse (> 0.5 s) DIM or BRIGHT
Orange	B05	ON/OFF BRIGHT/DIM	Short pulse (< 0.5 s) ON or OFF, Long pulse (> 0.5 s) DIM or BRIGHT
Yellow	B06	ON/OFF BRIGHT/DIM	Short pulse (< 0.5 s) ON or OFF, Long pulse (> 0.5 s) DIM or BRIGHT

\* Depends on the status of the switch actuator or address to be controlled (toggle mode).

**EATON** MBO 6019570G01 001 60

**per function**

**3.3 Sending dimming commands with retractive switches with two normally open contacts**

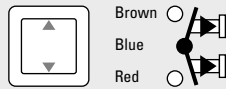

Send address (2 x)	A1...P16
Send set-up command (2 x)	DIM
Options	None

**Example of programming with address B03**

Action	No. of LED flashes
Send address <b>B03</b> (2 x)	2 x
Send set-up command <b>DIM</b> (2 x)	6 x

**EATON** MBO 6019570G01 001 61

**Programming** per function

**Result**

- Dim function is available on all inputs.
- Other inputs are automatically given consecutive addresses.

Input	Address	Sending	Operation
Brown	B03	ON/BRIGHT	Short pulse (< 0.5 s) ON, long pulse (> 0.5 s) BRIGHT
Red	B03	OFF/DIM	Short pulse (< 0.5 s) OFF, long pulse (> 0.5 s) DIM
Orange	B04	ON/BRIGHT	Short pulse (< 0.5 s) ON, long pulse (> 0.5 s) BRIGHT
Yellow	B04	OFF/DIM	Short pulse (< 0.5 s) OFF, long pulse (> 0.5 s) DIM

**EATON** MBO 6019570G01 001 62

**per function**

**3.4 Sending group commands with (rocker) switches or retractive switches**

Send address (2 x)	A1...P16
Send set-up command (2 x)	All Lights On
Options	None

**Example of programming on address B03**

Action	No. of LED flashes
Send address <b>B03</b> (2 x)	2 x
Send set-up command <b>All Lights On</b> (2 x)	8 x

**EATON** MBO 6019570G01 001 63

**Programming** per function

**Result**

Group commands available on the following inputs.

Input	Address	Sending	Operation
Brown	B	All Lights On	Sends All Lights On using letter code B when switch is pressed
Red	B	All Units Off	Sends All Units Off using letter code B when switch is pressed
Orange	B	All Lights Off	Sends All Lights Off using letter code B when switch is pressed
Yellow	B03	OFF	Sends OFF command when switch is pressed

**EATON** MBO 6019570G01 001 64

per function

**3.5 Sending commands for mechanical ventilation control using retractable switch with four normally open contacts and zero position**

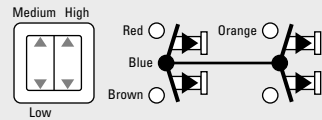

Send address (2 x)	A1...P16
Send set-up command (2 x)	HRQ
Options	None

**Example of programming for address L10**

Action	No. of LED flashes
Send address <b>L10</b> (2 x)	2 x
Send set-up command <b>HRQ*</b> (2 x)	12 x

\* Cannot be programmed using a remote control.



MBO 6019570G01 001 65

**Programming**

per function

**Result**

Ventilator function with the following setting.

Event	Result	Ventilator
Brown and blue make brief contact	IMX10 sends L10 LOff and L11 LOff	Low speed
Red and blue make brief contact	IMX10 sends L10 LOOn and L11 LOff	Medium speed
Orange and blue make brief contact	IMX10 sends L10 LOff and L11 LOOn	High speed
Yellow is not used for this function	n/a	n/a

66 MBO 6019570G01 001



per function

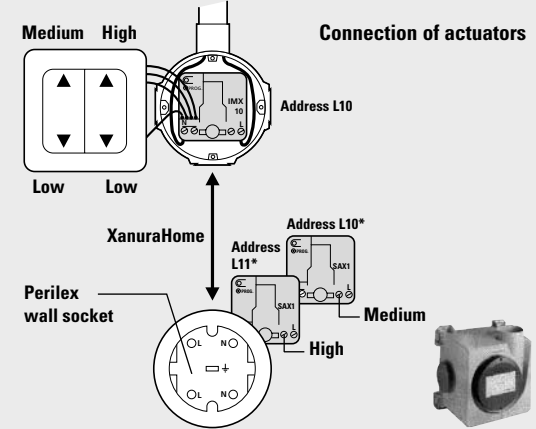

**Please note:**  
\* Each switch actuator must be fitted in a separate junction box.



MBO 6019570G01 001 67

**Programming**

per function

**Connection of actuators**

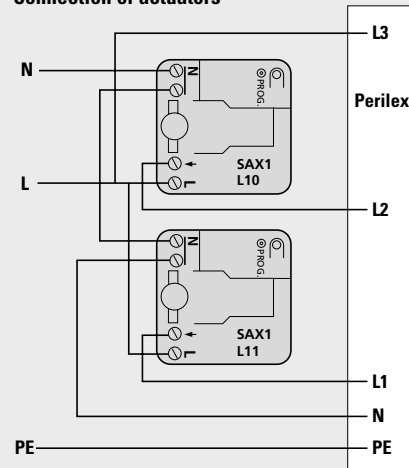

68 MBO 6019570G01 001



per function

The table below shows the operation and is based on the CML from Stork Air:

Ventilator	First connection connected to phase	Second connection connected to SAX1 address L10	Third connection connected to SAX1 address L11	Information
Off	L3	L2	L1	Perilex plug Usually not desirable
Low speed	230 V	0 V		
Medium speed	230 V	230 V*		
High speed	230 V	0 V of 230 V	230 V*	

\* Determines the speed.

**Please note:** Depending on the make/type of mechanical ventilation unit used, additional relays (Eaton no.: 1810 103) may be needed to use these mechanical ventilation circuits in combination with XanuraHome. Before using this circuit, make sure that the mechanical ventilation unit used can be controlled with XanuraHome. Check with the XanuraHome Step by Step Plan for more information. This can be downloaded from [www.xanurahome.nl](http://www.xanurahome.nl)



MBO 6019570G01 001 69

**Programming**

per input

**Programming per input**

The IMX10 can be programmed user defined, so that each input is assigned its own function and address. This allows the module to be programmed as flexibly as required.

To program per input, please follow these steps:

1. Set the module to Programming mode.
2. Send the address (A1...P16) for Input 1 twice.
3. Send the set-up command associated with the selected function for Input 1 twice.
4. Send **any** set-up commands for chosen options for Input 1 twice.
5. Repeat steps 2 to 4 for the next input and repeat the procedure until all inputs have been determined\*.
6. Exit the Programming mode.
7. Test the operation of all the inputs.

Check the number of flashes associated with each step.

\* If you stop in the meantime, the other inputs will automatically be given consecutive addresses with the same function based on the programming performed in the earlier step (providing the previous function permits this).

70 MBO 6019570G01 001



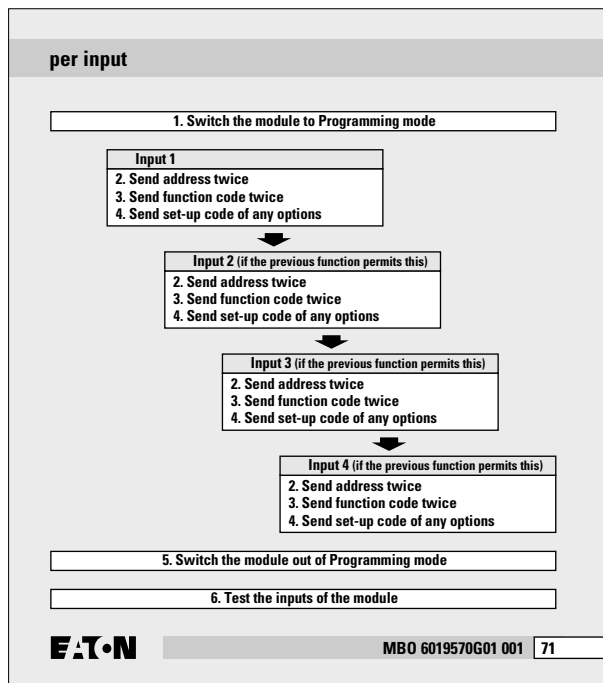

**Programming** per input

**Overview of functions and options per input**

**Functions programming table**

Function sends	Set-up command	No. of LED flashes
ON/OFF* switch commands <sup>1)</sup>	ON	3 x
Dim commands <sup>2)</sup>	Bright	5 x
	To step 4 Determining options	
Dim commands <sup>3)</sup>	DIM	6 x
Fixed mode ON/OFF <sup>1)</sup>	OFF	4 x
ON commands <sup>1)</sup>	SON	10 x
OFF commands <sup>1)</sup>	SOF	11 x
All Units Off group command <sup>1)</sup>	AUF	7 x
All Lights On group command <sup>1)</sup>	ALN	8 x
All Lights Off group command <sup>1)</sup>	ALF	9 x
	No options possible	

<sup>1)</sup> With retractive switch or switch.  
<sup>2)</sup> Only in combination with retractive switch, 1-pole, normally open contact.  
<sup>3)</sup> Only in combination with retractive switch, two normally open contacts (multi-switch).  
 \* Depends on the status of the switch actuator or address to be controlled (toggle mode).

**EATON** MBO 6019570G01 001 72

**per input**

**Options programming table**

Options	Set-up command	No. of LED flashes
Status change with All Units Off	AUF	4 x
Status change with All Lights On	ALN	2 x
Status change with All Lights Off	ALF	3 x

SON = Status On  
 SOF = Status Off  
 AUF = All Units Off  
 ALN = All Lights On  
 ALF = All Lights Off

**EATON** MBO 6019570G01 001 73

**Programming** per input

**Example**

Input 1 (brown) must send toggle **ON/OFF commands** on address B03 whereby the status of the input automatically changes on receiving an **All Lights On** and an **All Units Off** command.

Input 2 (red) must send **All Lights On** commands on letter code **D**.

Input 3 (orange) must send **DIM commands** connected to a retractive switch with two normally open contacts (multi-switch) on address **C12**.

Input 4 (yellow) is determined automatically by the choice of Input 3.

Actions to be performed:

- Set the module to Programming mode by pressing the programming button for three seconds until the LED lights up continuously.

**Input 1**

- Determine the address for **Input 1** (brown).
  - Send address **B03** twice over the power line, check that the LED flashes twice.

**EATON** MBO 6019570G01 001 74

**per input**

- Determine the set-up command for the function sending **ON/OFF commands in the toggle mode**.
  - Send the **ON** command twice over the power line; check that the LED flashes three times.
- Determine the set-up command for the status change options with **All Lights On** and **All Units Off**.
  - Send the **All Lights On** command twice over the power line; check that the LED flashes twice.
  - Send the **All Units Off** command twice over the power line; check that the LED flashes four times.

**Input 2**

- Determine the address for **Input 2** (red).
  - Send an address on letter code **D**, for example **D01** twice over the power line; check that the LED flashes twice.
- Determine the set-up command for the function sending **All Lights On** commands.
  - Send the **All Lights On** command twice over the power line; check that the LED flashes eight times.

**EATON** MBO 6019570G01 001 75

**Programming** per input

**Input 3**

- Determine the address for **Input 3** (orange).
  - Send address **C12** twice over the power line; check that the LED flashes twice.
- Determine the set-up command for the function sending **DIM commands** connected to a retractive switch with two normally open contacts (multi-switch).
  - Send the **DIM** command twice over the power line; check that the LED flashes six times.

Input 3 (orange) is now programmed to send ON/BRIGHT commands to address C12.

**Input 4**



Input 4 (yellow) is automatically programmed to send OFF/DIM commands to address C12.

- Exit the Programming mode of the module.
  - Press the Programming button or wait 60 seconds.
- Test the function of each input.

**EATON** MBO 6019570G01 001 76

## Technical data

### XanuraHome™ home automation

Rated voltage	230 Vac, 50 Hz
Current consumption	< 30 mA capacitive
Signal transmission	> 5 Vpp in 5 Ω at 120 kHz in accordance with EN 50065-1, EN 50065-2-1, EN 50065-4-1
Transmission synchronization	1 pulse burst at 0°/180°
Signal sensitivity	25 mVpp...6 Vpp at 120 kHz ± 4 kHz
Signal/noise ratio	1,35 : 1
Connection range	Up to 2.5 mm <sup>2</sup> , tightening torque 0.5 Nm
Minimum ambient temperature	0 °C
Maximum ambient temperature	40 °C (*)
Atmospheric pressure	86 pA - 106 pA
Relative humidity (non condensing)	30 tot 90%
Standards	NEN-EN-IEC 60669-2-1, NEN-EN-IEC 60669-2-2
Marking	 

(\*) XanuraHome modules are suitable for use in homes where the ambient temperature in the living area is not higher under normal circumstances than 35°C or may (exceptionally) reach a maximum of 40°C.

Subject to technical changes without prior notice.

**EATON**

MBO 6019570G01 001 77

## Undisturbed functioning of XanuraHome automation

Electrical equipment and systems can be sensitive to signals from other equipment, which causes electro magnetic disturbance. In the European Union, countries agreed upon laws for the immunity (sensitivity) of signals of other equipment as well as equipment emission (disturbance). When equipment or applications in a certain surrounding comply with the valid standards, they will not disturb each other's operations (they are called "Electro Magnetic Compatible").

For residential surroundings, where the home automation system XanuraHome is being applied, the European standard for immunity is standardised in EN 61000-6-1. Equipment that complies with this standard is resistant to electro magnetic emission of other equipment, which complies with the European standard EN 61000-6-3 for residential surroundings. Experience has shown that in domestic surroundings, equipment is being used which has an EMC-emission level that is above the levels stated in EN 61000-6-3. This equipment can disturb the correct functioning of the XanuraHome-modules. The immunity of the XanuraHome built-in modules is therefore reevaluated and equivalent to EN 61000-6-2 (the more severe European standard for immunity in industrial surroundings).

**Nevertheless, the application area for XanuraHome will remain restricted to residential areas.**

78 MBO 6019570G01 001

**EATON**

**Eaton is therefore not responsible for the disfunctioning of the XanuraHome system as a consequence of equipment in the building with emission levels that exceed the maximum allowed levels set as standard for residential, commercial and semi-industrial surroundings stated in EN 61000-6-3.**

Application area	Valid European Standard		XanuraHome-home automation*
	Immunity of equipment	Emission of equipment	Immunity and emission standards
Residential	61000-6-1	61000-6-3	Compatible/ meets the requirements
Commercial			
Semi-industrial			

\* Condition is that the total XanuraHome-system is installed in accordance with valid instructions supplied by a certified and trained XanuraHome dealer.

**EATON**

MBO 6019570G01 001 79

Eaton Electric B.V.  
P.O. Box 23  
7550 AA Hengelo  
The Netherlands  
Tel.: 074 246 70 00  
Fax: 074 246 33 02  
steunpunt@eaton.com  
www.et-instalateur.nl  
www.xanurahome.nl

**EATON**